

VITI IMPERDIBILI PER LAMIERA
PANEL FASTENERS FOR SHEET METAL
VIS CAPTIVES POUR TÔLE
UNVERLIERBARE SCHRAUBEN FÜR BLECH
TORNILLOS IMPERDIBLES PARA CHAPA

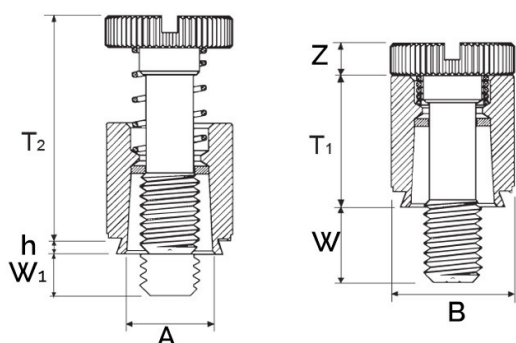

Thread size x pitch	A Max	B +/-0.25	Hole Size +0.08	T2 Nom	h Max	Min. Sheet Thickness	Min. Dist. to edge	W +/-0.4	Z +/-0.13	T1 Max	W1 +/- 0.41
M5 x 0.8	8.72	10.31	8.74	17.53	1.53	1.53	8.65	11.1	2.08	11.47	3.2

MATERIAL: ZINC PLATED STEEL

sheet hardness max 80 HRB

Disegno di proprietà della Fixi S.r.l. - Non può essere copiato, riprodotto o comunicato a terze persone senza autorizzazione.
 Drawing owned by Fixi S.r.l.- It cannot be copied, reproduced or communicated to third parties without permission.

Disegnato da / Designed by: Ufficio Tecnico
Ufficio Tecnico / Tech Office: tech@fixi.it

11/01/2025

CODICE PRODOTTO / PART NUMBER

15PFS2M572

FIXI®

FIXI s.r.l. Via Bellardi 40/A
 10146 - Torino (Italy)
 www.fixi.it - info@fixi.it