

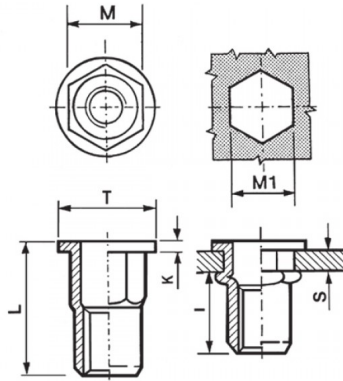







INSERTI FILETTATI SEMIESAGONALI INOX A4 - TESTA TONDA
SEMI-HEXAGONAL A4 STAINLESS STEEL THREADED INSERTS - FLAT HEAD
INSERTS FILETÉS CRANTÉS CYLINDRIQUES ACIER INOX A4- TÊTE CYLINDRIQUE
BLINDNIETMUTTERN TEILSECHSKANT EDELSTAHL A4 - FLACHKOPF
TUERCAS REMACHABLES SEMI-HEXAGONALES INOX A4 - CABEZA PLANA



	S GRIP	D		T +/-0,5	K +/-0,15	L +/-0,5	I ~	
M5	0,5-3,0	6,9	7	10	1	12	7,5	8,5

MATERIAL: STAINLESS STEEL A4

			
MAX TIGHTENING TORQUE (Nm) 8.5	PULL-OUT FORCE (N) 11500	TORQUE TO TURN (Nm) 2	SHEAR FORCE (N) 2000

Disegno di proprietà della Fixi S.r.l. - Non può essere copiato, riprodotto o comunicato a terze persone senza autorizzazione.
 Drawing owned by Fixi S.r.l.- It cannot be copied, reproduced or communicated to third parties without permission.

Disegnato da / Designed by: Ufficio Tecnico
Ufficio Tecnico / Tech Office: tech@fixi.it

22/12/2024

CODICE PRODOTTO / PART NUMBER

85IXA4ITTSEM05C

FIXI®

FIXI s.r.l. Via Bellardi 40/A
 10146 - Torino (Italy)
 www.fixi.it - info@fixi.it