

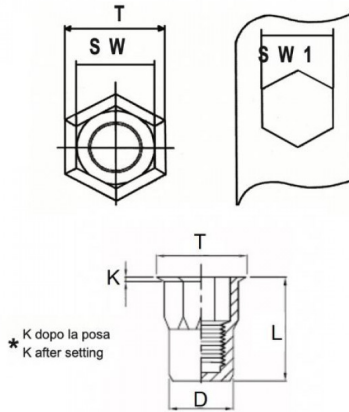





**INSERTI FILETTATI SEMIESAGONALI CIECHI TESTA RIDOTTA**  
**SEMI-HEXAGONAL THREADED INSERTS CLOSED END TYPE REDUCED HEAD**  
**INSERTS FILETÉS SEMI-HEXAGONAUX BORGNES TÊTE RÉDUITE**  
**BLINDNIETMUTTERN TEILSECHSKANT GESCHLOSSEN KLEINER SENKKOPF**  
**TUERCAS REMACHABLES SEMI-HEXAGONALES CIEGAS CABEZA REDUCIDA**



|  | SW1<br>+0,01/-0 | SW<br>+0,07/-0,1 | T<br>+/-0,5 | K<br>+/-0,15 | L<br>+/-0,5 |  | GRIP  |
|---|-----------------|------------------|-------------|--------------|-------------|---|-------|
| M4  | 6               | 5,9              | 7           | 0,6          | 16,5        | 3   | 0,5-3 |

**MATERIAL: STAINLESS STEEL A4**

|   |  |  |   |
|---|--|--|---|
| <br>MAX TIGHTENING<br>TORQUE (Nm)<br>3 | <br>PULL-OUT<br>FORCE (N)<br>6800 | <br>TORQUE TO<br>TURN (Nm)<br>0,8 | <br>SHEAR<br>FORCE (N)<br>1500 |
|---|--|--|---|

Disegno di proprietà della Fixi S.r.l. - Non può essere copiato, riprodotto o comunicato a terze persone senza autorizzazione.  
 Drawing owned by Fixi S.r.l.- It cannot be copied, reproduced or communicated to third parties without permission.

**Disegnato da / Designed by:** Ufficio Tecnico  
**Ufficio Tecnico / Tech Office:** tech@fixi.it

08/09/2024

**CODICE PRODOTTO / PART NUMBER**

85IXA4IERSECM04C

**FIXI®**

FIXI s.r.l. Via Bellardi 40/A  
 10146 - Torino (Italy)  
 www.fixi.it - info@fixi.it