

BUSSOLE AUTOFILETTANTI TIPO F318 - FORI APERTI
SELF-TAPPING THREADED INSERTS F318 TYPE - OPEN HOLES
DOUILLES AUTOTARAUDEUSES TYPE F318 - TROUS OUVERTS
SELBSTSCHNEIDENDE GEWINDEBUCHSEN TYP F318 - OFFENE LÖCHER
INSERTOS ROSCADOS AUTOTALADRANTES TIPO F318 - AGUJEROS ABIERTOS

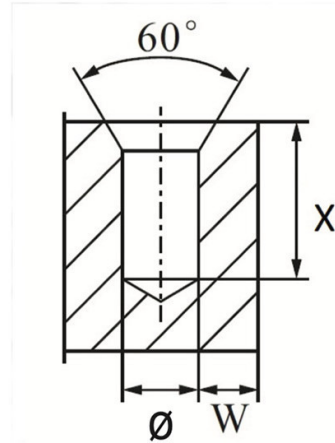
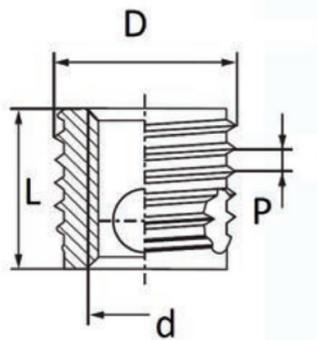

d	D	P*	Ø hole metals	Ø hole hard plastic	X	L
Internal thread	External thread					
M6X1,0	10	1,25	9,5-9,6	9,3-9,5	10	8

MATERIALE/MATERIALS: Acciaio temprato, zincato / Case-hardened zinc plated steel

Disegno di proprietà della Fixi S.r.l. - Non può essere copiato, riprodotto o comunicato a terze persone senza autorizzazione.
 Drawing owned by Fixi S.r.l.- It cannot be copied, reproduced or communicated to third parties without permission.

Disegnato da / Designed by: Ufficio Tecnico
Ufficio Tecnico / Tech Office: tech@fixi.it

27/12/2024

CODICE PRODOTTO / PART NUMBER

83ACF318M06-C

FIXI®

FIXI s.r.l. Via Bellardi 40/A
 10146 - Torino (Italy)
 www.fixi.it - info@fixi.it