

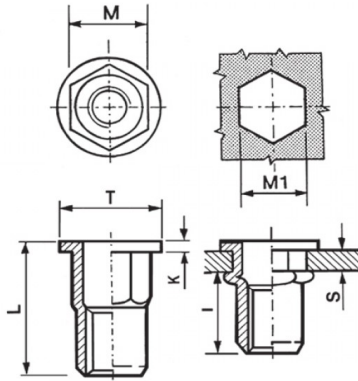





**INSERTI FILETTATI SEMIESAGONALI ACCIAIO - TESTA TONDA**  
**SEMI-HEXAGONAL STEEL THREADED INSERTS - FLAT HEAD**  
**INSERTS FILETÉS SEMI-HEXAGONAUX ACIER - TÊTE CYLINDRIQUE**  
**BLINDNIETMUTTERN TEILSECHSKANT STAHL- FLACHKOPF**  
**TUERCAS REMACHABLES SEMI-HEXAGONALES ACERO - CABEZA PLANA**



	S GRIP	M	M1	T	K	L	I	
M3	0.5 - 1.5	+0,07-0,1	+0,1/-0	+/-0,5	+/-0,15	+/-0,5	~	2

**MATERIAL:** STEEL ZINC PLATED CR III

 MAX TIGHTENING TORQUE (Nm) 2	 PULL-OUT FORCE (N) 3900	 TORQUE TO TURN (Nm) 0,5	 SHEAR FORCE (N) 900
---	--	--	--

Disegno di proprietà della Fixi S.r.l. - Non può essere copiato, riprodotto o comunicato a terze persone senza autorizzazione.  
 Drawing owned by Fixi S.r.l.- It cannot be copied, reproduced or communicated to third parties without permission.

**Disegnato da / Designed by:** Ufficio Tecnico  
**Ufficio Tecnico / Tech Office:** tech@fixi.it

03/01/2025

**CODICE PRODOTTO / PART NUMBER**

85ACITTSEM03C

**FIXI®**

FIXI s.r.l. Via Bellardi 40/A  
 10146 - Torino (Italy)  
 www.fixi.it - info@fixi.it