

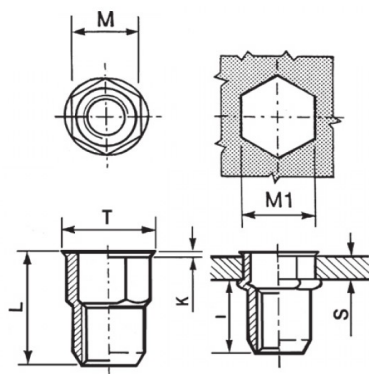

INSERTI FILETTATI SEMIESAGONALI ACCIAIO - TESTA RIDOTTA
SEMI-HEXAGONAL STEEL THREADED INSERTS - REDUCED COUNTERSUNK HEAD
INSERTS FILETÉS SEMI-HEXAGONAUX ACIER - TÊTE RÉDUITE COURT
BLINDNIETMUTTERN TEILSECHSKANT STAHL - KLEINER SENKKOPF
TUERCAS REMACHABLES SEMI-HEXAGONALES ACERO - CABEZA REDUCIDA



K dopo la posa
K after setting



	S	M	M1	T	K	L	I	
	GRIP	+0,07-0,1	+0,1/-0	+/-0,5	+/-0,15	+/-0,5	~	Nm
M3	0.3 - 1.5	4.9	5	6	0.5	9	5.5	1

MATERIALE: ACCIAIO Z.B. CROMO III

			
COPPIA DI SERRAGGIO MASSIMA (Nm)	CARICO DI TRAZIONE SUL FILETTO (N)	TENUTA ALLA COPPIA DIRETTA (Nm)	VALORI AL TAGLIO (N)
1	3900	0,4	900

Disegno di proprietà della Fixi S.r.l. - Non può essere copiato, riprodotto o comunicato a terze persone senza autorizzazione.
 Drawing owned by Fixi S.r.l.- It cannot be copied, reproduced or communicated to third parties without permission.

Disegnato da / Designed by: Ufficio Tecnico
 Ufficio Tecnico / Tech Office: tech@fixi.it

26/12/2024

CODICE PRODOTTO / PART NUMBER

85ACIERSEM03C

FIXI®

FIXI s.r.l. Via Bellardi 40/A
 10146 - Torino (Italy)
 www.fixi.it - info@fixi.it