

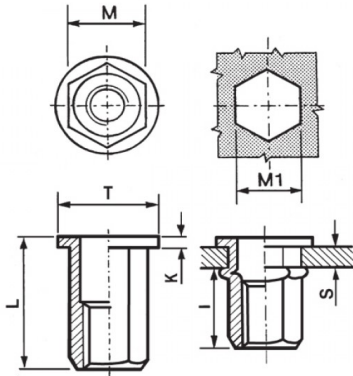





**INSERTI FILETTATI ESAGONALI ACCIAIO - TESTA TONDA**  
**HEXAGONAL STEEL THREADED INSERTS - FLAT HEAD**  
**INSERTS FILETÉS HEXAGONAUX ACIER - TÊTE CYLINDRIQUE**  
**BLINDNIETMUTTERN SECHSKANTSCHAFT STAHL - FLACHKOPF**  
**TUERCAS REMACHABLES HEXAGONALES STAHL - CABEZA PLANA**



	S	M	M1	T	K	L	I	
	GRIP	+0,07-0,1	+0,1/-0	+/-0,5	+/-0,15	+/-0,5	~	
M12	1 - 3.5	14.9	15	19	2	24.3	16	80

**MATERIAL:** STEEL ZINC PLATED CR III

			
MAX TIGHTENING TORQUE (Nm)	PULL-OUT FORCE (N)	TORQUE TO TURN (Nm)	SHEAR FORCE (N)
80	34000	30	6500

Disegno di proprietà della Fixi S.r.l. - Non può essere copiato, riprodotto o comunicato a terze persone senza autorizzazione.  
 Drawing owned by Fixi S.r.l.- It cannot be copied, reproduced or communicated to third parties without permission.

**Disegnato da / Designed by:** Ufficio Tecnico  
**Ufficio Tecnico / Tech Office:** tech@fixi.it

22/12/2024

**CODICE PRODOTTO / PART NUMBER**

85ACITTEM12C15

**FIXI®**

FIXI s.r.l. Via Bellardi 40/A  
 10146 - Torino (Italy)  
 www.fixi.it - info@fixi.it