

INSERTI FILETTATI SEMIESAGONALI CIECHI - TESTA RIDOTTA

SEMI-HEXAGONAL THREADED INSERTS CLOSED END TYPE - REDUCED COUNTERSUNK H.

INSERTS FILETÉS SEMI-HEXAGONAUX BORGNES - TÊTE RÉDUITE

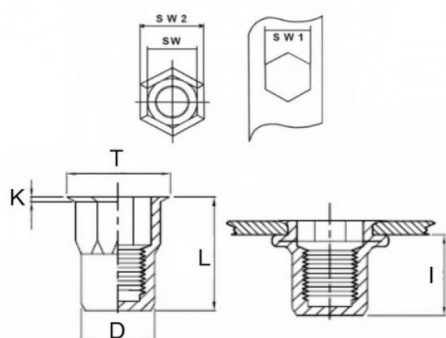

BLINDNIETMUTTERN TEILSECHSKANT GESCHLOSSEN - KLEINER SENKKOPF

TUERCAS REMACHABLES SEMI-HEXAGONALES CIEGAS - CABEZA REDUCIDA



K dopo la posa
K after setting



	GRIP	SW1 +0,01/-0	SW +0,07/-0,1	T +/-0,5	K +/-0,15	L +/-0,5	I	
M4	0,5 - 2,0	6	5,9	7	0.5	16	11,5	3

MATERIAL: STAINLESS STEEL A2

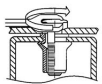
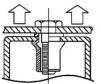
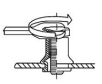
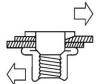
 MAX TIGHTENING TORQUE (Nm) 3	 PULL-OUT FORCE (N) 6800	 TORQUE TO TURN (Nm) 0,8	 SHEAR FORCE (N) 1500
---	--	--	---

Disegno di proprietà della Fixi S.r.l. - Non può essere copiato, riprodotto o comunicato a terze persone senza autorizzazione.
Drawing owned by Fixi S.r.l.- It cannot be copied, reproduced or communicated to third parties without permission.

Disegnato da / Designed by: Ufficio Tecnico
Ufficio Tecnico / Tech Office: tech@fixi.it

26/12/2024

CODICE PRODOTTO / PART NUMBER

85IXIERSECM04C

FIXI®

FIXI s.r.l. Via Bellardi 40/A
10146 - Torino (Italy)
www.fixi.it - info@fixi.it