

**INSERTI FILETTATI SEMIESAGONALI CIECHI - TESTA RIDOTTA**

**SEMI-HEXAGONAL THREADED INSERTS CLOSED END TYPE - REDUCED COUNTERSUNK H.**

**INSERTS FILETÉS SEMI-HEXAGONAUX BORGNES - TÊTE RÉDUITE**

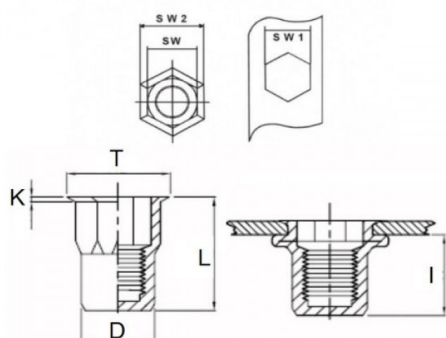

**BLINDNIETMUTTERN TEILSECHSKANT GESCHLOSSEN - KLEINER SENKKOPF**

**TUERCAS REMACHABLES SEMI-HEXAGONALES CIEGAS - CABEZA REDUCIDA**



K dopo la posa  
K after setting



	GRIP	SW1 +0,01/-0	SW +0,07/-0,1	T +/-0,5	K +/-0,15	L +/-0,5	I	
M12	0,8 - 4	16	15,9	17.5	0,75	31,1	23	50

**MATERIAL: STAINLESS STEEL A2**

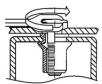
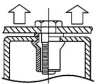
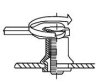
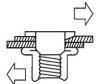
 MAX TIGHTENING TORQUE (Nm) 32	 PULL-OUT FORCE (N) 32000	 TORQUE TO TURN (Nm) 8,5	 SHEAR FORCE (N) 5000
--	---	--	---

Disegno di proprietà della Fixi S.r.l. - Non può essere copiato, riprodotto o comunicato a terze persone senza autorizzazione.  
Drawing owned by Fixi S.r.l.- It cannot be copied, reproduced or communicated to third parties without permission.

Disegnato da / Designed by: Ufficio Tecnico  
Ufficio Tecnico / Tech Office: tech@fixi.it

26/12/2024

**CODICE PRODOTTO / PART NUMBER**

**85IXIERSECM12C16**

**FIXI®**

FIXI s.r.l. Via Bellardi 40/A  
10146 - Torino (Italy)  
www.fixi.it - info@fixi.it